

*raumplus SPECIFICATION SHEET - Sliding Door – S3000\_AIR\_SDB\_Doors-In-Connector, 42-Series*

JOB NO:  
PROJECT:  
LOCATION:

DATE:  
VERSION:  
CODE:



MODEL NO.:	S3000_AIR_SDB_Doors-In-Connector [SYM / ASYM]	SUPPLIER:	iLiving Co Ltd
BRAND:	raumplus GMBH	CONTACT:	Mr Michael Fung
DESCRIPTION:	S3000_AIR_SDB_Doors-In-Connector	PHONE:	(852) 2832-7878
FINISH:	anodised aluminum / light bronze / black matt powder coat	EMAIL_1:	<a href="mailto:michaelfung@iLiving.hk">michaelfung@iLiving.hk</a>
COLOUR:	alu silver / bronze / black matt	EMAIL_2:	<a href="mailto:project.iLiving@gmail.com">project.iLiving@gmail.com</a>
ORIGIN:	Made in EU	ADDRESS:	Room 903, 9/F, C C Wu BLDG, 302-308 Hennessy Road, Wan Chai. HK

SIZE/THICKNESS: min./max. door width = 500mm-1200mm; door height = 700mm-2750mm; 42mm thickness

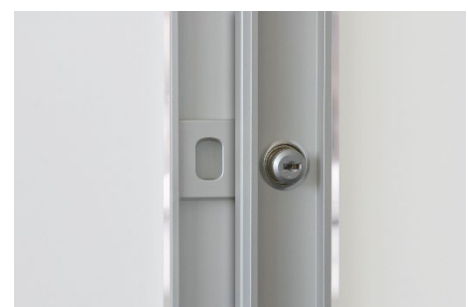
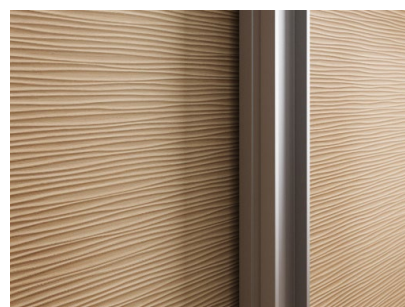
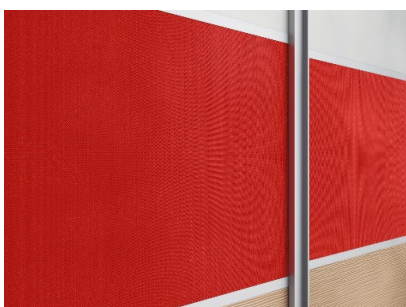
IMAGE/SAMPLE:

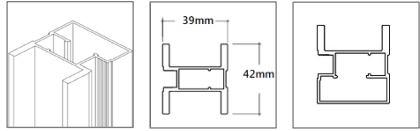
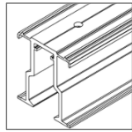
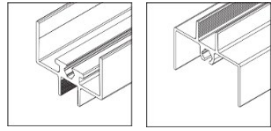
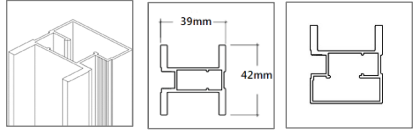

Supply sliding door with alu silver / light bronze / black matt aluminum frames (stiles);  
 Panel (laminated, MFC, MDF) to be provided by others, maximum 10mm thickness,  
 Panel (glass) to be provided by others, maximum 8mm thickness (equip with relevant gasket),  
 and all necessary raumplus parts and other accessories as per Specification.

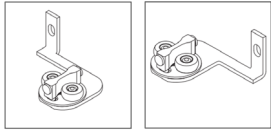
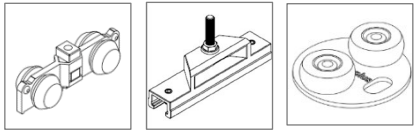
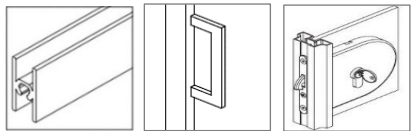
	Descriptions	Material Specifications	Country of Origin	
1	Brand	raumplus	Germany	<b>raumplus</b>
2	Model	S3000 AIR Stile; symmetrical [SYM]; asymmetrical [ASYM]	Made in EU	
3	Top track AIR SDB	Anodised aluminum	Made in EU	
4	Top and bottom rails	Anodised aluminum; light bronze; black matt powder coat	Made in EU	
5	S3000 AIR Stile	Anodised aluminum; light bronze; black matt powder coat; front face = 39mm side width = 42mm	Made in EU	
6	Panel	To be provided by Others	-	-
7	SDB	Soft Closing Device	Made in EU	
8	AIR Door Connector	Left and right	Made in EU	
9	Necessary raumplus component parts	Top Roller AIR; Pick-up Element; Ground Plate With Roller 38mm	Made in EU	
10	Optional raumplus component parts	Dividing Rail [vertical / horizontal]; Handle Square 40115; Turning Bolt Lock	Made in EU	

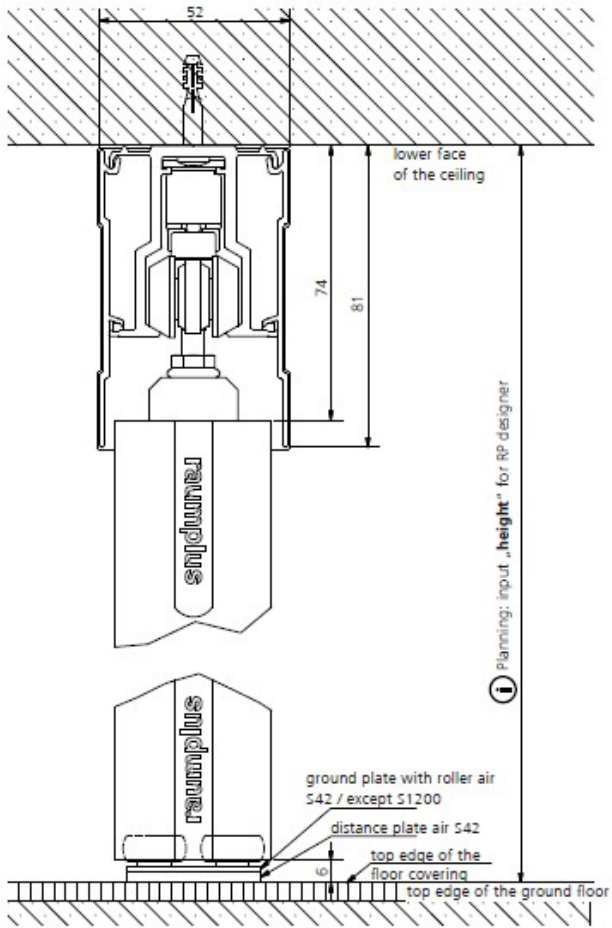

Stile height = clear height - 80 mm

PROVISIONAL CEILING MOUNTING – 42 SERIES\_AIR\_SDB

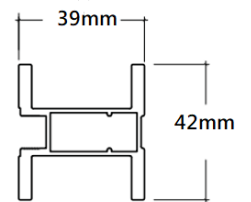
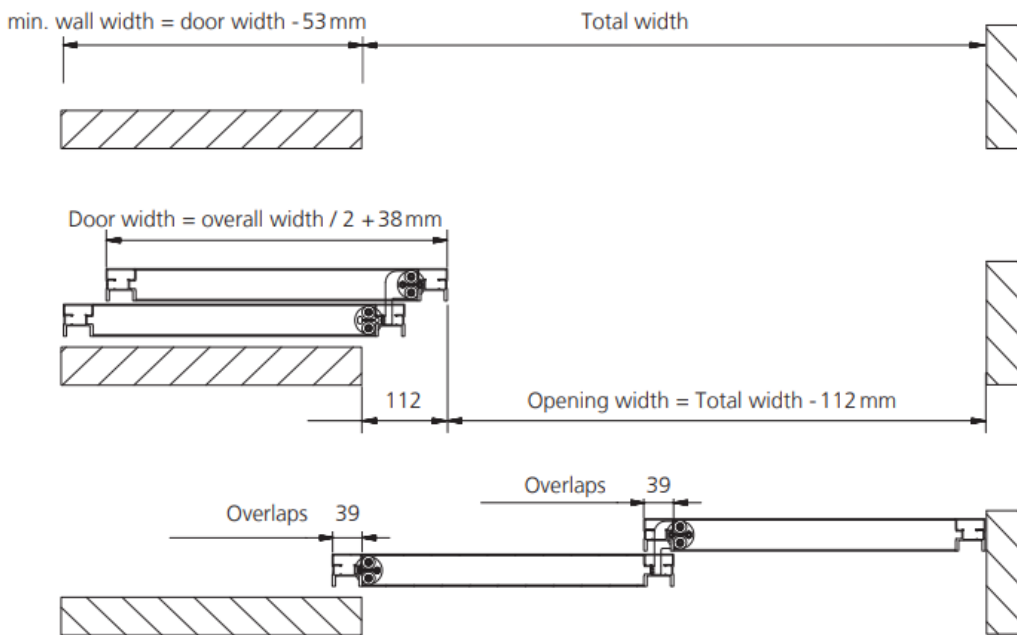

SLIDING DOOR OVERLAPPING

STILE – S3000 SERIES

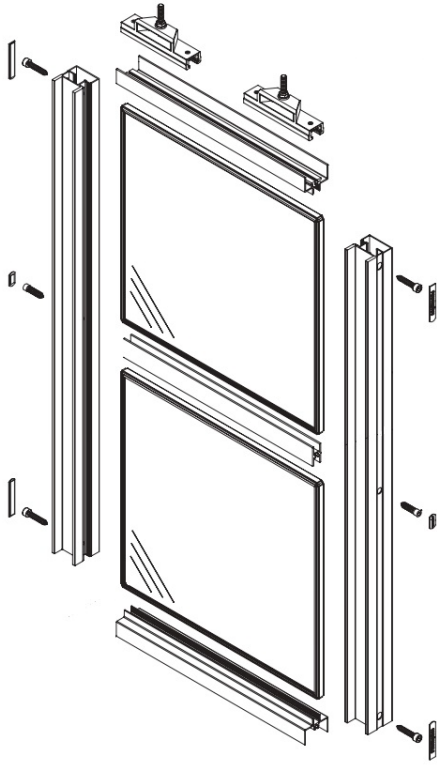

EXPLODED DRAWING – RAUMPLUS S3000 AIR SERIES