

*raumplus SPECIFICATION SHEET - Sliding Door - S1500\_T\_SDB, 42-Series*

JOB NO:  
PROJECT:  
LOCATION:



DATE:  
VERSION:  
CODE:

MODEL NO.:	S1500_T_SDB [SQ / SYM / ASYM]	SUPPLIER:	iLiving Co Ltd
BRAND:	raumplus GMBH	CONTACT:	Mr Michael Fung
DESCRIPTION:	S1500_T_SDB	PHONE:	(852) 2832-7878
FINISH:	anodised aluminum / light bronze / black matt powder coat	EMAIL_1:	<a href="mailto:michaelfung@iLiving.hk">michaelfung@iLiving.hk</a>
COLOUR:	alu silver / bronze / black matt	EMAIL_2:	<a href="mailto:project.iLiving@gmail.com">project.iLiving@gmail.com</a>
ORIGIN:	Made in EU	ADDRESS:	Room 903, 9/F, C C Wu BLDG, 302-308 Hennessy Road, Wan Chai. HK

SIZE/THICKNESS: min./max. door width = 500mm-1500mm; door height = 700mm-3000mm; 42mm thickness  
IMAGE/SAMPLE:

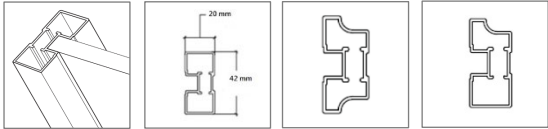
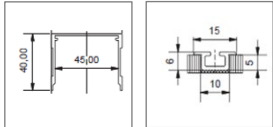
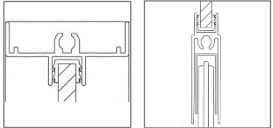
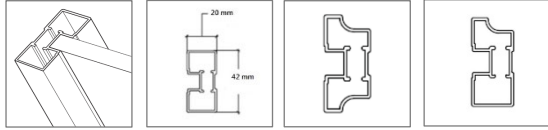
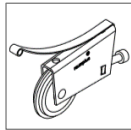
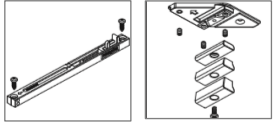

Supply sliding door with alu silver / light bronze / black matt aluminum frames (stiles);  
 Panel (laminare, MFC, MDF) to be provided by others, maximum 10mm thickness,  
 Panel (glass) to be provided by others, maximum 8mm thickness (equip with relevant gasket),  
 and all necessary raumplus parts and other accessories as per Specification.

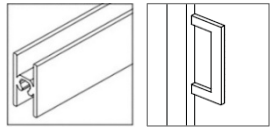
	Descriptions	Material Specifications	Country of Origin	
1	Brand	raumplus	Germany	<b>raumplus</b>
2	Model	S1500 Stile; square frame [SQ]; symmetrical [SYM]; asymmetrical [ASYM]	Made in EU	
3	Top and bottom tracks	Anodised aluminum; light bronze; black matt powder coat	Made in EU	
4	Top and bottom rails	Anodised aluminum; light bronze; black matt powder coat	Made in EU	
5	S1500 Stile	Anodised aluminum; light bronze; black matt powder coat; front face = 20mm side width = 42mm	Made in EU	
6	Panel	To be provided by Others	-	-
7	Bottom Roller	Steel and nylon	Made in EU	
8	SDB	Soft Closing Device	Made in EU	
9	Necessary raumplus component parts	Top Roller; Glass Gasket	made in EU	
10	Optional raumplus component parts	Dividing Rail [vertical / horizontal]; Handle Square 40115	Made in EU	

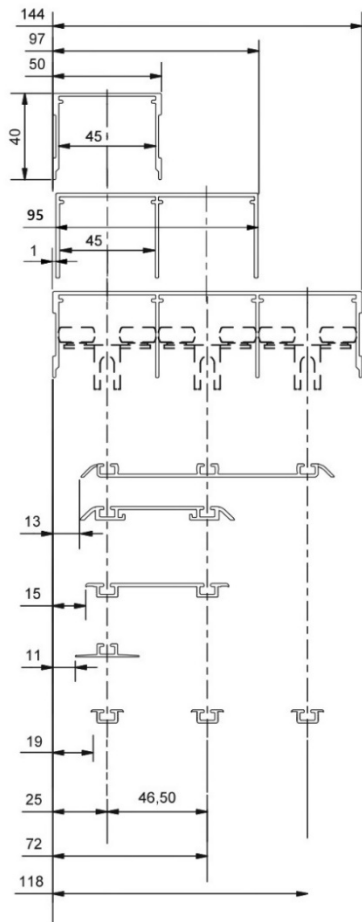

POSITION OF BOTTOM TRACK – 42 SERIES [S1500/S3000]

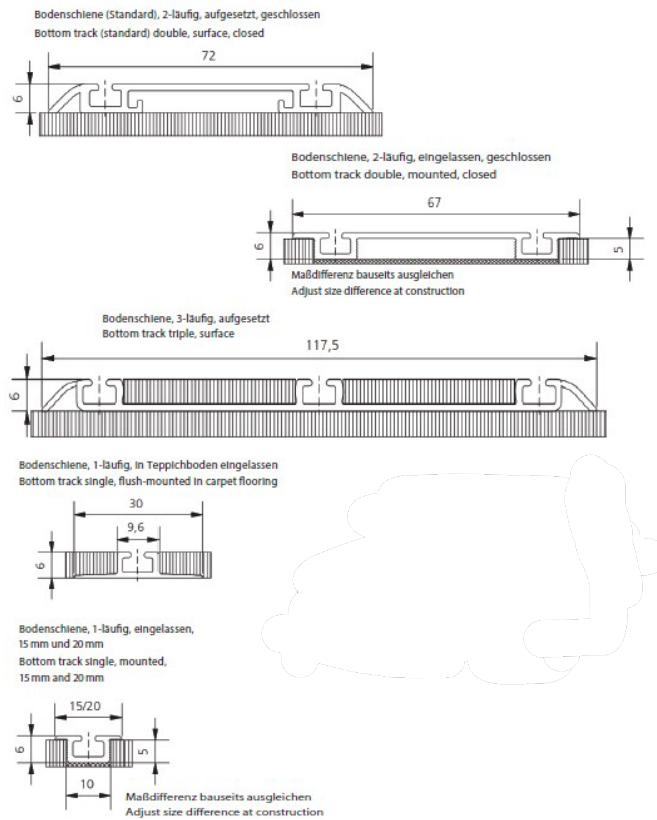

OVERVIEW OF BOTTOM TRACK – 42 SERIES

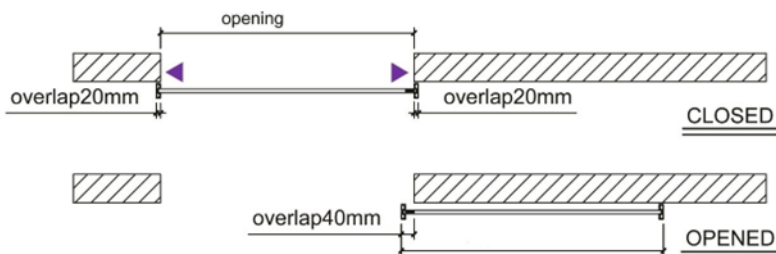

SLIDING DOOR OVERLAPPING

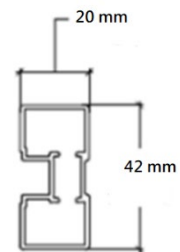

STILE – S1500 SERIES

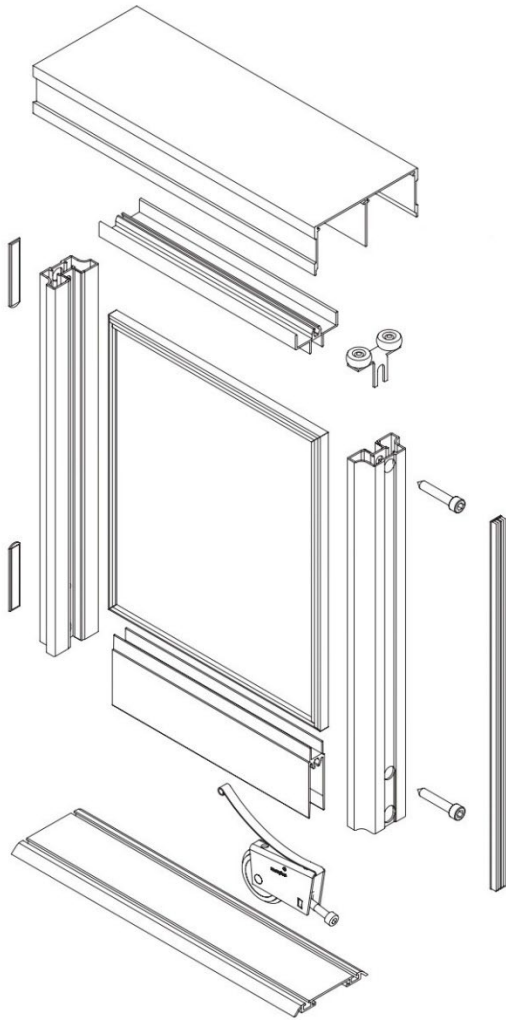

EXPLODED DRAWING – RAUMPLUS S1500 SERIES