

raumplus SPECIFICATION SHEET - Sliding Door - S1200_Slide-Fold, 42-Series

JOB NO:
PROJECT:
LOCATION:

DATE:
VERSION:
CODE:

| | | | |
|--------------|---|-----------|--|
| MODEL NO.: | S1200_Slide-Fold | SUPPLIER: | iLiving Co Ltd |
| BRAND: | raumplus GMBH | CONTACT: | Mr Michael Fung |
| DESCRIPTION: | S1200_Slide-Fold | PHONE: | (852) 2832-7878 |
| FINISH: | anodised aluminum / light bronze / black matt powder coat | EMAIL_1: | michaelfung@iLiving.hk |
| COLOUR: | alu silver / bronze / black matt | EMAIL_2: | project.iLiving@gmail.com |
| ORIGIN: | Made in EU | ADDRESS: | Room 903, 9/F, C C Wu BLDG, 302-308 Hennessy Road, Wan Chai. HK |

SIZE/THICKNESS: min./max. door width = 350mm-750mm; door height = 700mm-2750mm; 42mm thickness
IMAGE/SAMPLE:

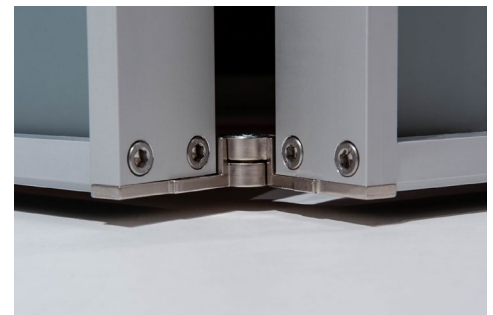
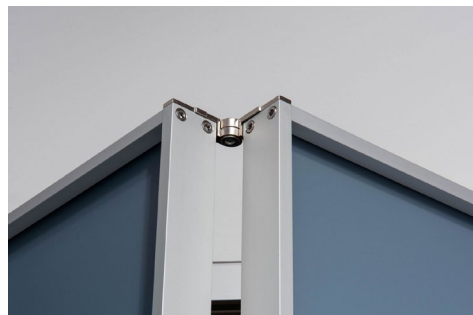

Supply sliding door with alu silver / light bronze / black matt aluminum frames (stiles);
 Panel (laminated, MFC, MDF) to be provided by others, maximum 10mm thickness,
 Panel (glass) to be provided by others, maximum 8mm thickness (equip with relevant gasket),
 and all necessary raumplus parts and other accessories as per Specification.

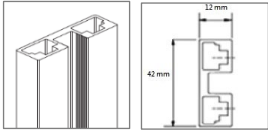
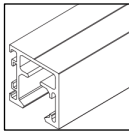
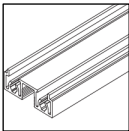
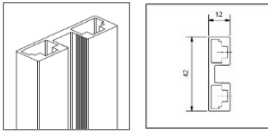
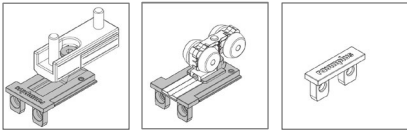
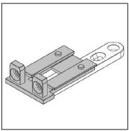
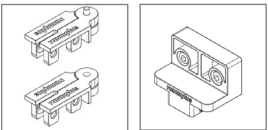
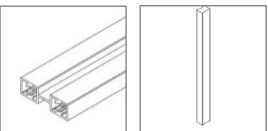
| | Descriptions | Material Specifications | Country of Origin | |
|----|------------------------------------|---|-------------------|--|
| 1 | Brand | raumplus | Germany | raumplus |
| 2 | Model | S1200 Stile | Made in EU |  |
| 3 | Top tracks | Anodised aluminum; light bronze; black matt powder coat | Made in EU |  |
| 4 | Top & bottom rails | Anodised aluminum; light bronze; black matt powder coat | Made in EU |  |
| 5 | S1200 Stile | Anodised aluminum; light bronze; black matt powder coat; front face = 12 mm side width = 42mm | Made in EU |  |
| 6 | Panel | To be provided by Others | - | - |
| 7 | Top Fitting | Pick Up Element set; Top Roller incl. Pick Up Element; Frame Connector | Made in EU |  |
| 8 | Bottom Fitting | Mounting Plate; Magnetic Self-Adhesive; Magnetic | Made in EU |  |
| 9 | Necessary raumplus component parts | Folding Door Hinge; Top Positioning | Made in EU |  |
| 10 | Optional raumplus component parts | Dividing Rail [vertical/horizontal]; Concave Handle | Made in EU |  |

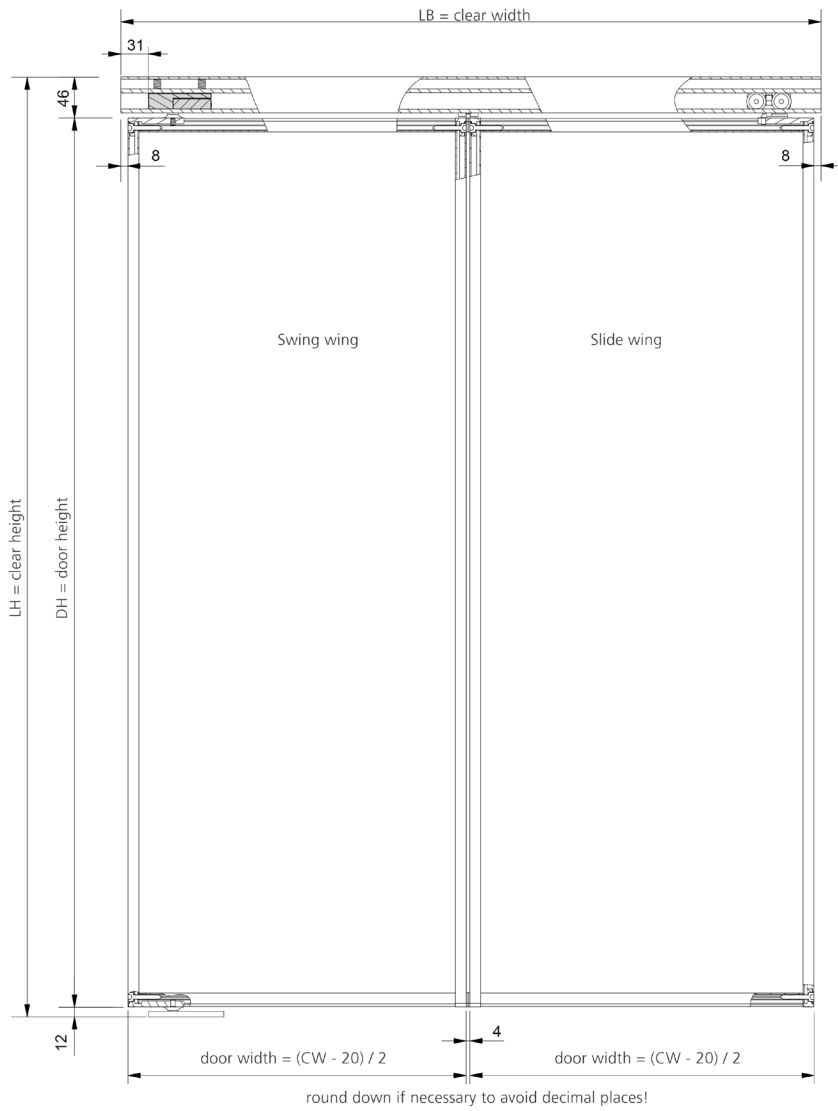

DETAIL DRAWINGS – RAUMPLUS S1200 SERIES_SLIDE FOLD

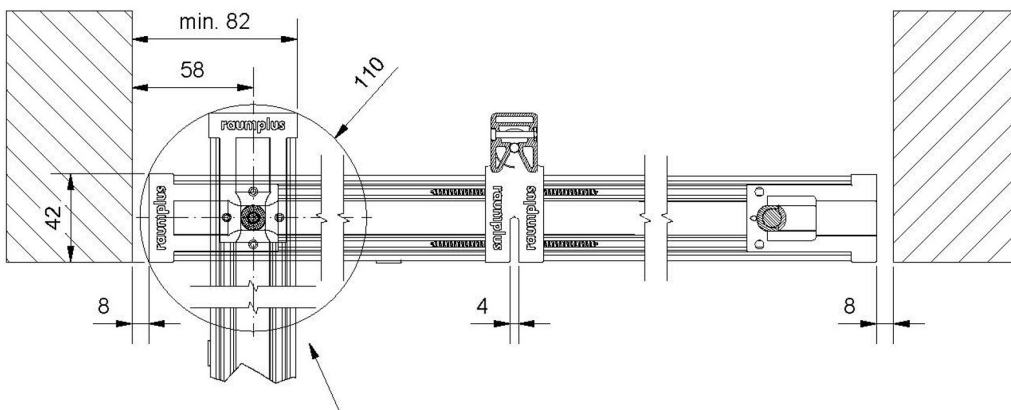

SPACE REQUIRED FOR INSTALLATION:

Distance to the interior system 100 mm.

Measured from ceiling rail to outer edge of interior system.

space requirement

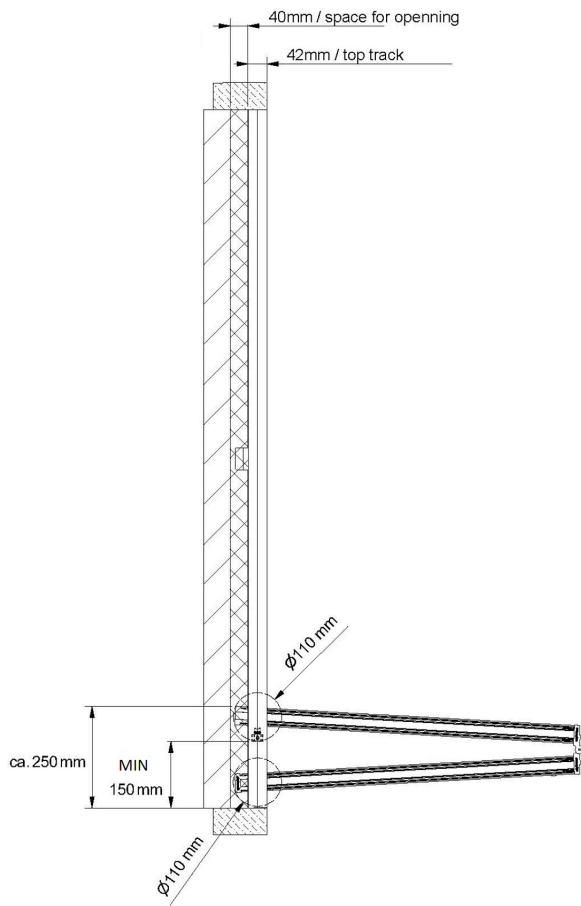

HORIZONTAL SECTION FOLDING DOOR SPACE RERUIREMENT

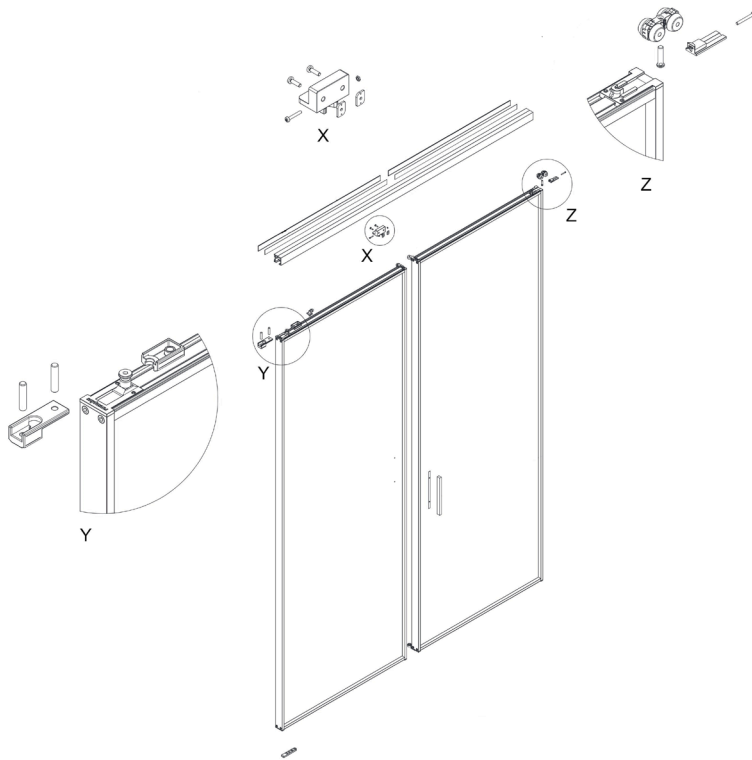

EXPLODED DRAWING – RAUMPLUS S1200 SERIES_SLIDE FOLD

JAN 2025

