

raumplus SPECIFICATION SHEET - Sliding Door - S1500_T_SDB_Magnetic Doors-In-Connector, 42-Series

JOB NO:
PROJECT:
LOCATION:

DATE:
VERSION:
CODE:

| | | | |
|--------------|---|-----------|--|
| MODEL NO.: | S1500_T_SDB_Magnetic Doors-In-Connector [SQ / ASYM] | SUPPLIER: | iLiving Co Ltd |
| BRAND: | raumplus GMBH | CONTACT: | Mr Michael Fung |
| DESCRIPTION: | S1500_T_SDB_Magnetic Doors-In-Connector | PHONE: | (852) 2832-7878 |
| FINISH: | anodised aluminum / light bronze / black matt powder coat | EMAIL_1: | michaelfung@iLiving.hk |
| COLOUR: | alu silver / bronze / black matt | EMAIL_2: | project.iLiving@gmail.com |
| ORGIN: | Made in EU | ADDRESS: | Room 903, 9/F, C C Wu BLDG, 302-308 Hennessy Road, Wan Chai. HK |

SIZE/THICKNESS: min./max. door width = 500mm-1500mm; door height = 700mm-3000mm; 42mm thickness
IMAGE/SAMPLE:

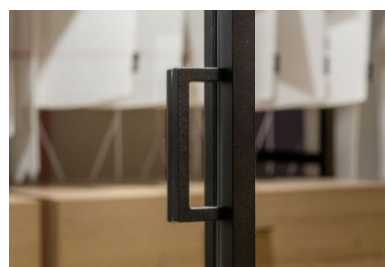
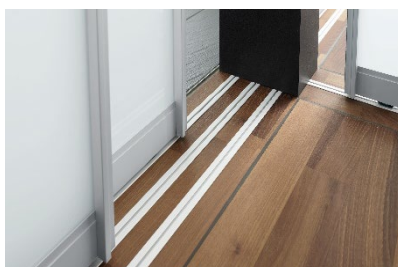

Supply sliding door with alu silver / light bronze / black matt aluminum frames (stiles);
 Panel (laminate, MFC, MDF) to be provided by others, maximum 10mm thickness,
 Panel (glass) to be provided by others, maximum 8mm thickness (equip with relevant gasket),
 and all necessary raumplus parts and other accessories as per Specification.

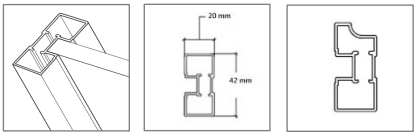
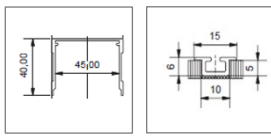
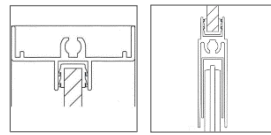
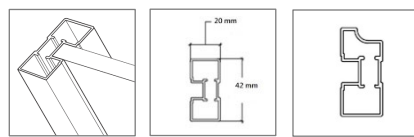
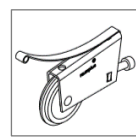
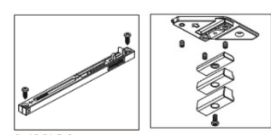
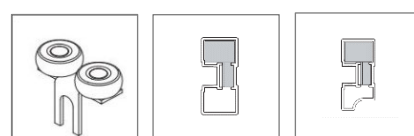
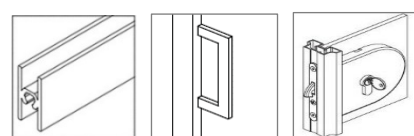
| | Descriptions | Material Specifications | Country of Origin | |
|----|------------------------------------|---|-------------------|--|
| 1 | Brand | raumplus | Germany | raumplus |
| 2 | Model | S1500 Stile; square frame [SQ]; asymmetrical [ASYM] | Made in EU |  |
| 3 | Top and bottom tracks | Anodised aluminum; light bronze; black matt powder coat | Made in EU |  |
| 4 | Top and bottom rails | Anodised aluminum; light bronze; black matt powder coat | Made in EU |  |
| 5 | S1500 Stile | Anodised aluminum; light bronze; black matt powder coat front face=20mm; side width=42mm | Made in EU |  |
| 6 | Panel | To be provided by Others | - | - |
| 7 | Bottom Roller | Steel and nylon | Made in EU |  |
| 8 | SDB | Soft Closing Device; SDB Positioning | Made in EU |  |
| 9 | Necessary raumplus component parts | Top Roller; Magnetic Door Connector; Glass Gasket | Made in EU |  |
| 10 | Optional raumplus component parts | Dividing Rail [vertical / horizontal]; Handle Square 40115; Turning Bolt Lock | Made in EU |  |

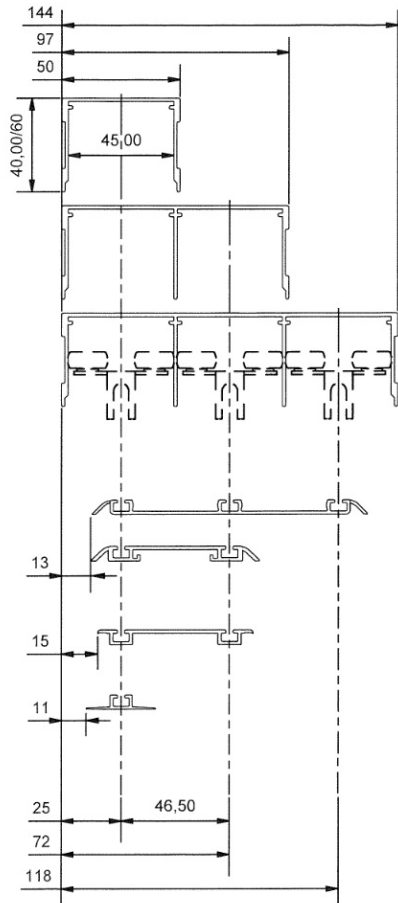

POSITION OF BOTTOM TRACK-42 SERIES [S1500/S3000]

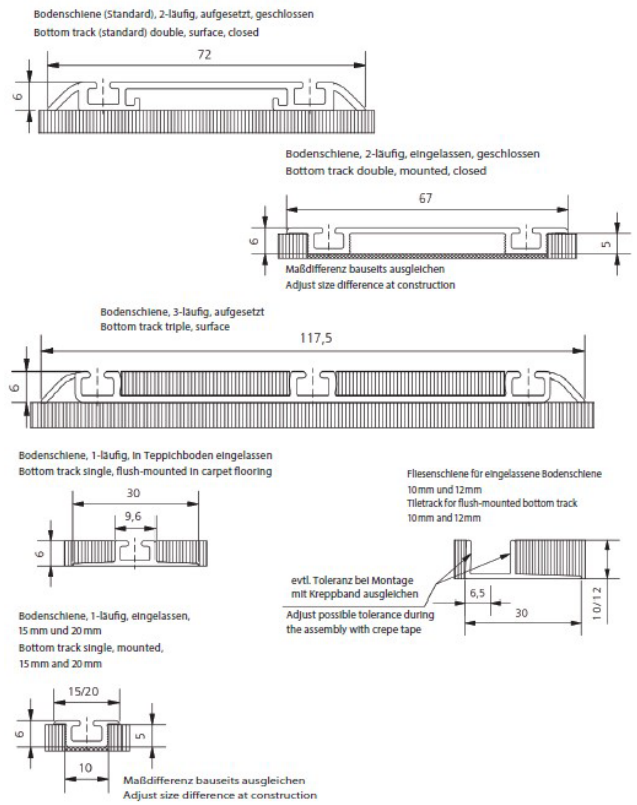

OVERVIEW OF BOTTOM TRACK – 42 SERIES

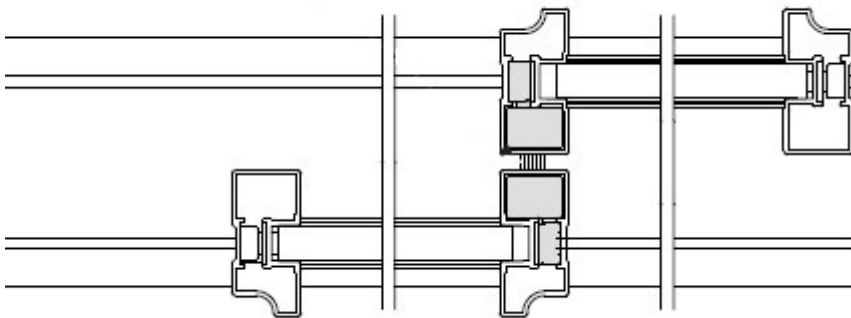

POSITION OF MAGNETIC DOOR CONNECTOR

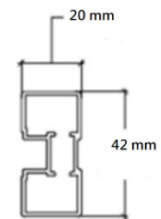

STILE – S1500 SERIES

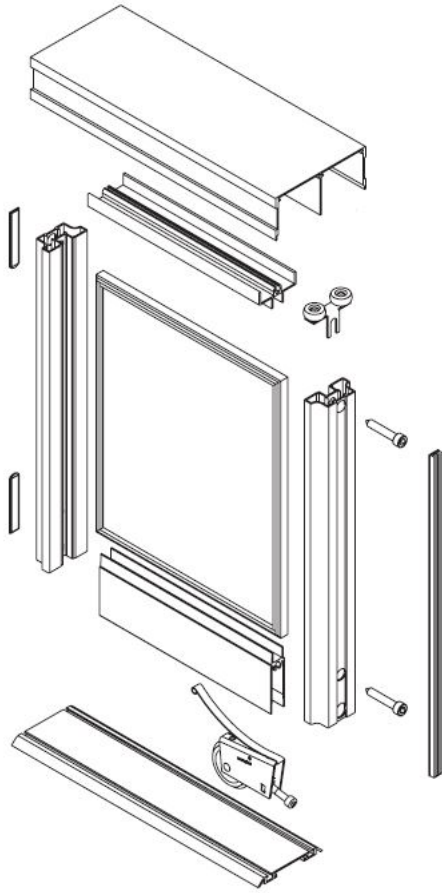

EXPLODED DRAWING – RAUMPLUS S1500 SERIES