

## raumplus SPECIFICATION SHEET - Swing Door – Swing Slim Line\_ Double

JOB NO:  
PROJECT:  
LOCATION:

DATE:  
VERSION:  
CODE:

MODEL NO.:	Swing Slim Line Double	SUPPLIER:	iLiving Co Ltd
BRAND:	raumplus GMBH	CONTACT:	Mr Michael Fung
DESCRIPTION:	Swing Slim Line Double	PHONE:	(852) 2832-7878
FINISH:	anodised aluminum / anodised black	EMAIL_1:	<a href="mailto:michaelfung@iLiving.hk">michaelfung@iLiving.hk</a>
COLOUR:	alu silver / anodised black	EMAIL_2:	<a href="mailto:project.iLiving@gmail.com">project.iLiving@gmail.com</a>
ORIGIN:	Made in EU	ADDRESS:	Room 903, 9/F, C C Wu BLDG, 302-308 Hennessy Road, Wan Chai. HK

SIZE/THICKNESS: min./max. active door width = 600mm-975mm; min./max. inactive door width = 200mm-975mm; max door height = 2478mm; 42mm thickness

IMAGE/SAMPLE:

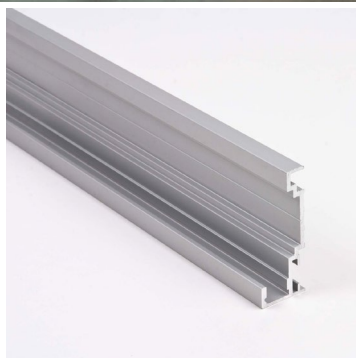

Supply swing door with alu silver / anodised black frames (stiles);  
 Panel (laminated, MFC, MDF) to be provided by others, maximum 10mm thickness,  
 Panel (glass) to be provided by others, maximum 8mm thickness (equip with relevant gasket),  
 and all necessary raumplus parts and other accessories as per Specification.

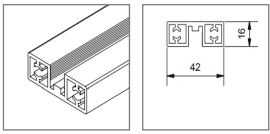
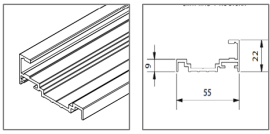
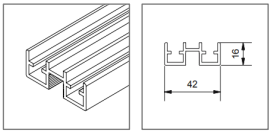
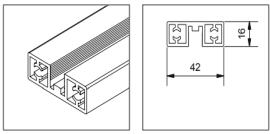
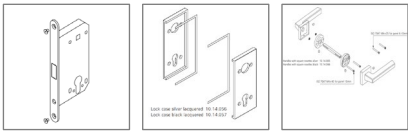
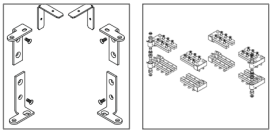
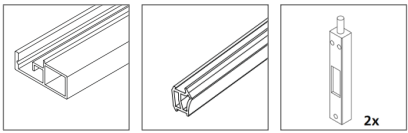
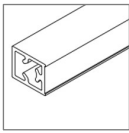
	Descriptions	Material Specifications	Country of Origin	
1	Brand	raumplus	Germany	
2	Model	Swing Slim Line	Made in EU	
3	Door jamb	Anodised aluminum; anodised black	Made in EU	
4	Top and bottom rail	Anodised aluminum; anodised black	Made in EU	
5	Swing Slim stile	Anodised aluminum; anodised black; front face = 16mm side width = 42mm	Made in EU	
6	Panel	To be provided by Others	-	-
7	Handle with magnetic lock	Magnetic lock; Case for magnetic lock; Handles with square rosettes	Made in EU	
8	180° Hinge	180° Hinge hardware set; 180° Hinge fitting set	Made in EU	
9	Necessary raumplus component part	Door stop profile; Gasket for door stop; Edge bolt; Cover for edge bolt	Made in EU	
10	Optional raumplus component parts	Dividing rail [vertical / horizontal]	Made in EU	

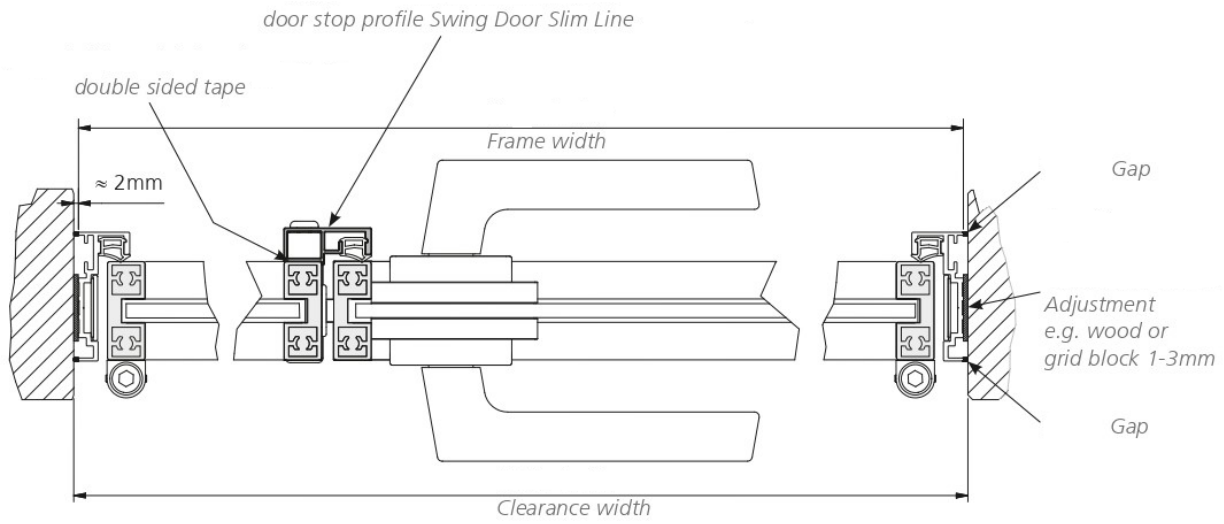

HORIZONTAL SECTION – SWING SLIM DOUBLE

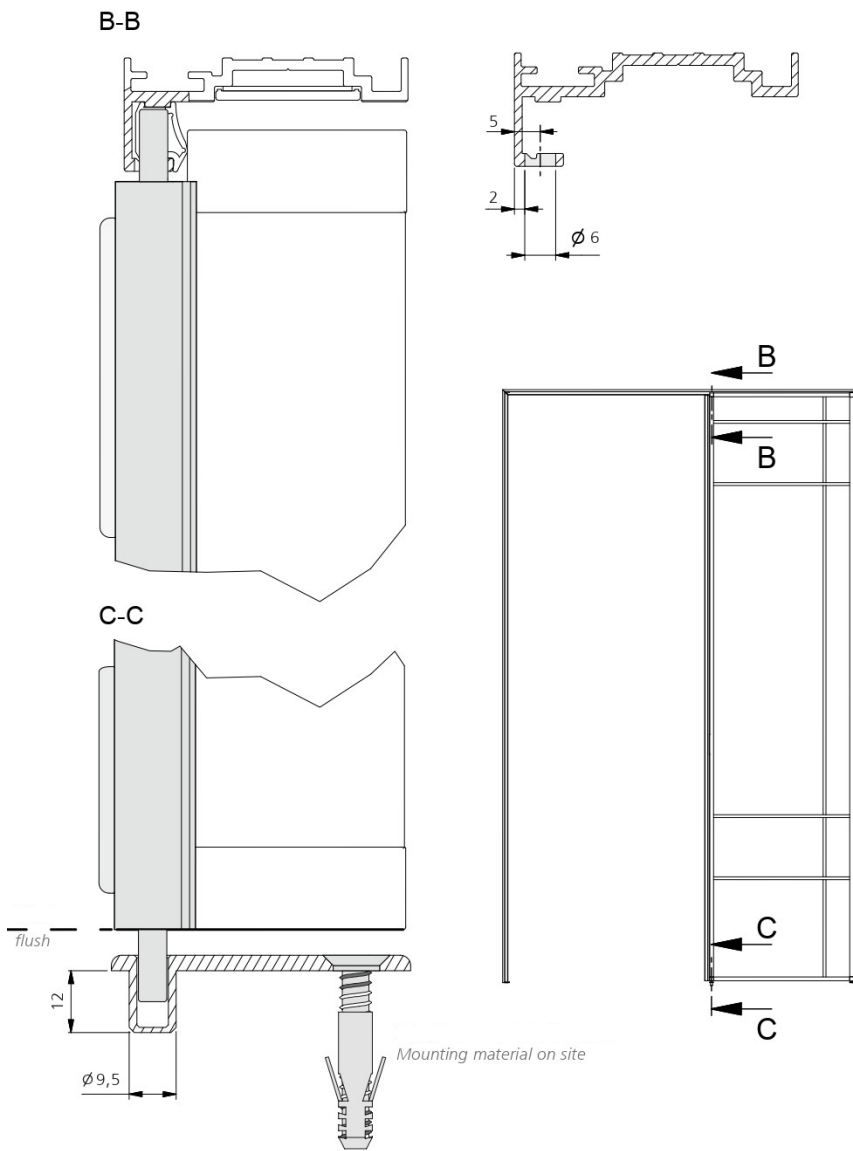

POSITION OF EDGEBOIT