

raumplus SPECIFICATION SHEET - Sliding Door - S1200_AIR_SDB, 42-Series

JOB NO:
PROJECT:
LOCATION:

DATE:
VERSION:
CODE:

MODEL NO.:	S1200_AIR_SDB	SUPPLIER:	iLiving Co Ltd
BRAND:	raumplus GMBH	CONTACT:	Mr Michael Fung
DESCRIPTION:	S1200_AIR_SDB	PHONE:	(852) 2832-7878
FINISH:	anodised aluminum / light bronze / black matt powder coat	EMAIL_1:	michaelfung@iLiving.hk
COLOUR:	alu silver / bronze / black matt	EMAIL_2:	project.iLiving@gmail.com
ORIGIN:	Made in EU	ADDRESS:	Room 903, 9/F, C C Wu BLDG, 302-308 Hennessy Road, Wan Chai. HK

SIZE/THICKNESS: min./max. door width = 500mm-1400mm; door height = 700mm-3000mm; 42mm thickness
IMAGE/SAMPLE:

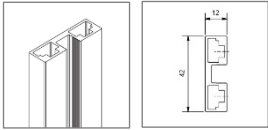
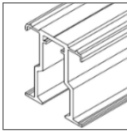
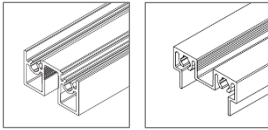
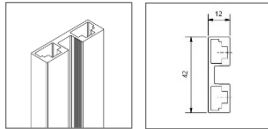
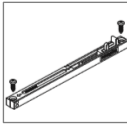
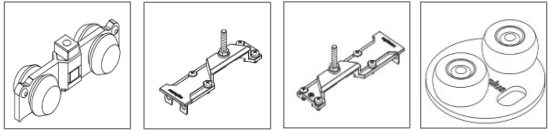
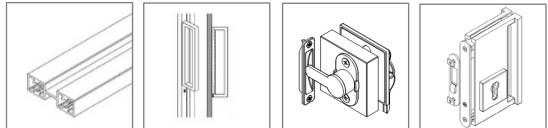

Supply sliding door with alu silver / light bronze / black matt aluminum frames (stiles);
 Panel (laminate, MFC, MDF) to be provided by others, maximum 10mm thickness,
 Panel (glass) to be provided by others, maximum 8mm thickness (equip with relevant gasket),
 and all necessary raumplus parts and other accessories as per Specification.

	Descriptions	Material Specifications	Country of Origin	
1	Brand	raumplus	Germany	
2	Model	S1200 Stile	Made in EU	
3	Top track AIR SDB	Anodised aluminum	Made in EU	
4	Top and bottom rail	Anodised aluminum; light bronze; black matt powder coat	Made in EU	
5	S1200 AIR Stile	Anodised aluminum; light bronze; black matt powder coat; front face = 12 mm side width = 42mm	Made in EU	
6	Panel	To be provided by Others	-	-
7	SDB	Soft Closing Device	Made in EU	
8	Necessary raumplus component parts	Top roller AIR SDB Pick-up element (Left and Right); Ground Plate with roller 38mm	Made in EU	
9	Optional raumplus component parts	Dividing rail [vertical / horizontal]; Floating handle; Pressure Bolt Lock S1200; Turning Bolt Lock S1200	Made in EU	

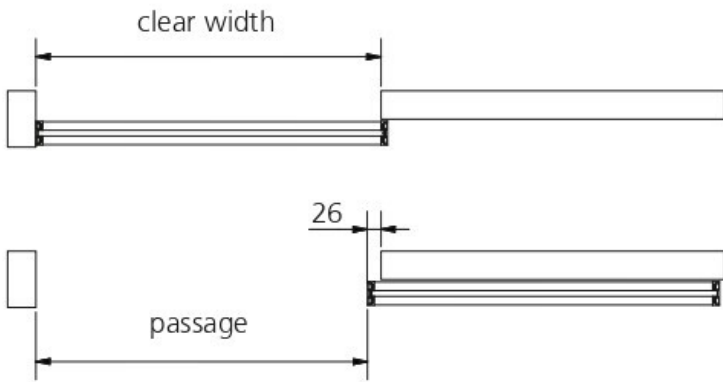

1-SLIDING DOOR OVERLAPPING

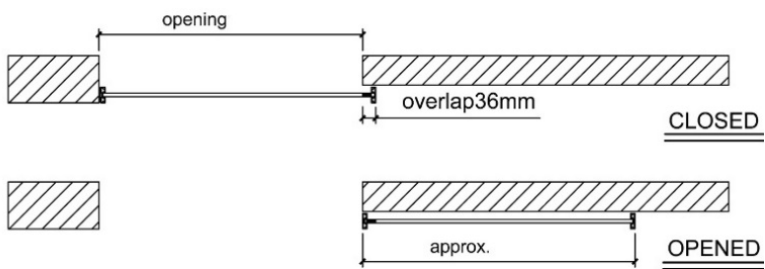

1-SLIDING DOOR OVERLAPPING (FLUSH)

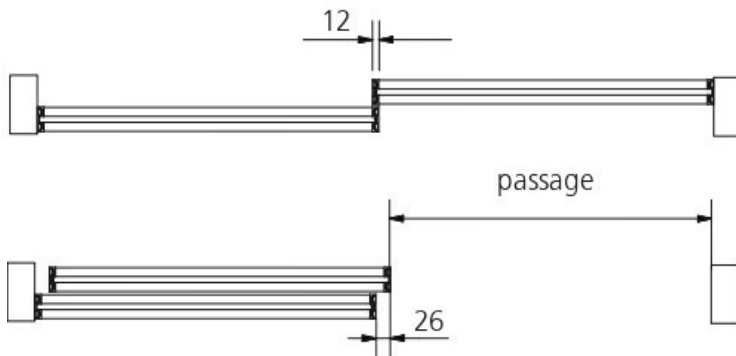

2-SLIDING DOOR OVERLAPPING

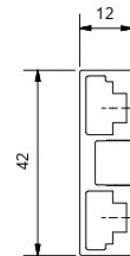

STILE – S1200 SERIES

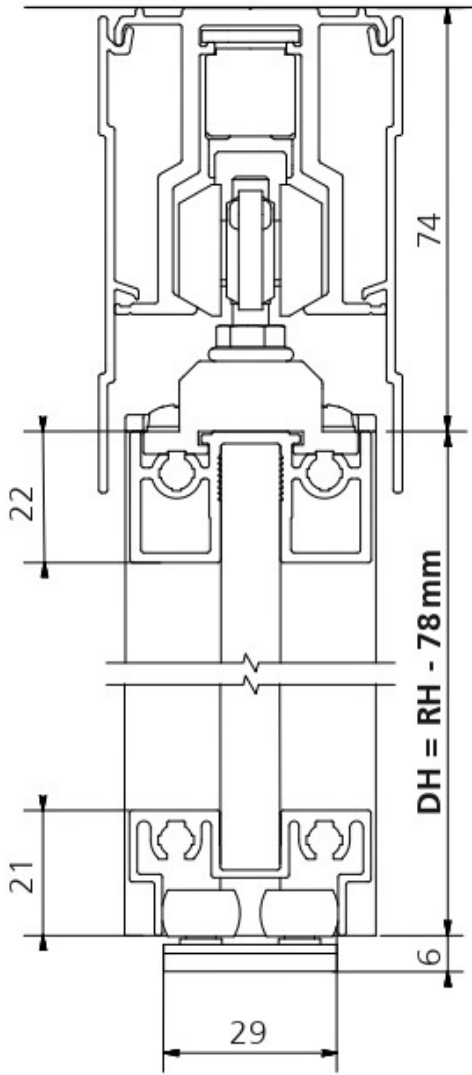

VERTICAL SECTION [S1200_AIR_SDB]

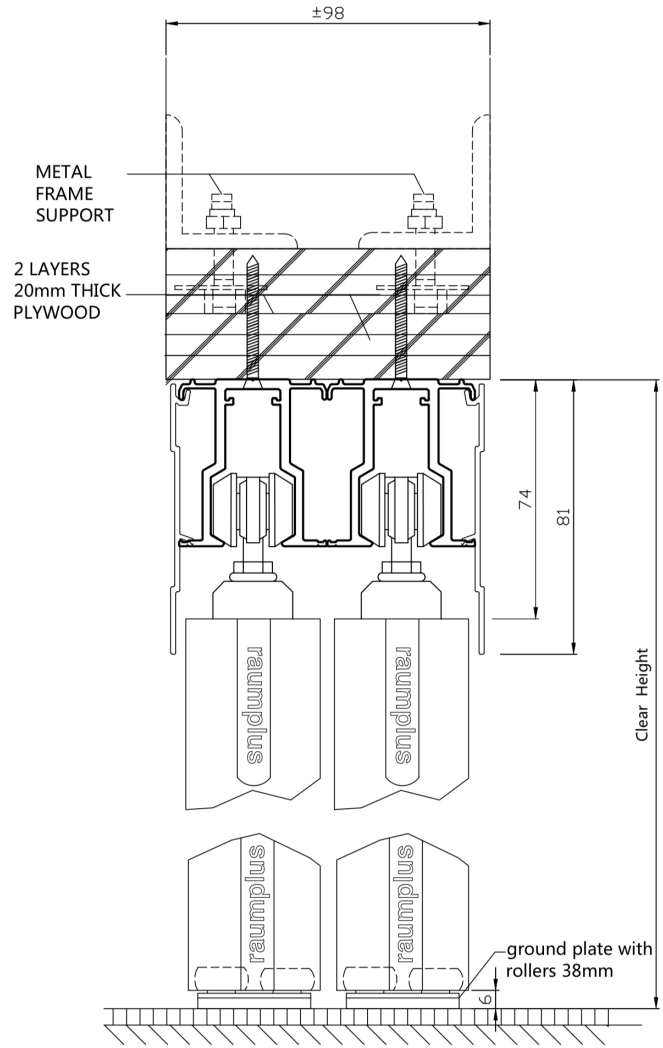

STANDARD CEILING MOUNT PROVISION – S42 AIR SERIES

Panel **without** gasket

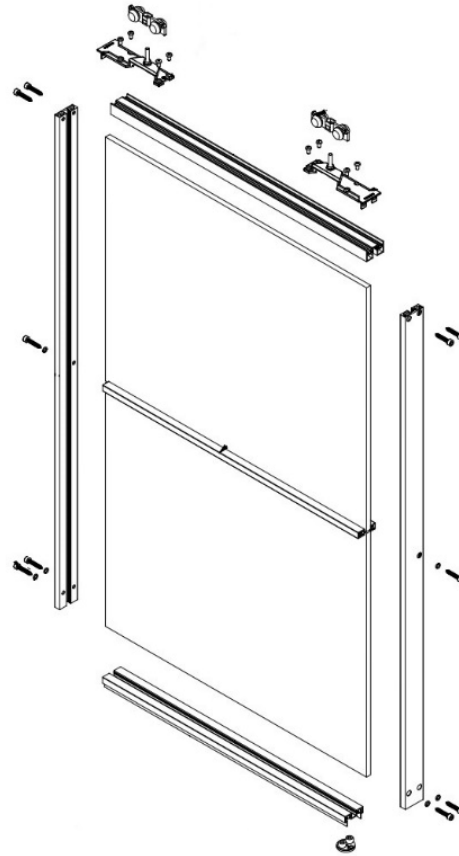
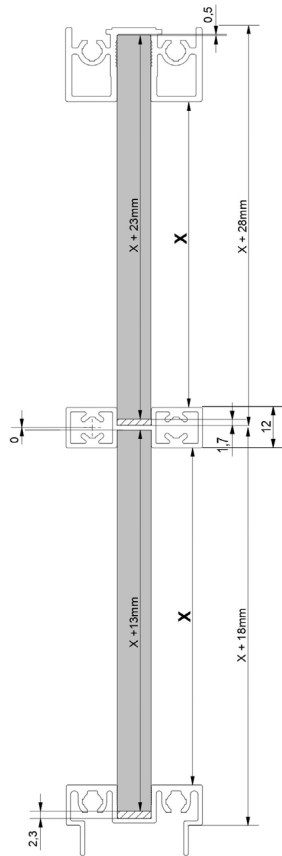

DETAIL SECTION – S1200 DIVIDING RAILS

EXPLODED DRAWING RAUMPLUS S1200 AIR SERIES